

1 9 9 9 C H R Y S L E R



3 0 0 M • L H S • C O N C O R D E • C I R R U S L X i
S E B R I N G C O N V E R T I B L E • S E B R I N G C O U P E
T O W N & C O U N T R Y



Town & Country Limited



Sebring Limited Convertible



Concorde LXi



Chrysler LHS

Great cars have always shared certain abiding characteristics: tasteful design; elegant amenities; masterful engineering; impeccable road manners, and the passion of their creators ... attributes embraced by this family of 1999 Chryslers. The tastefully designed Concorde is the latest sculpted evolution of the original Concorde's acclaimed cab-forward architecture—the same revolutionary form adapted to Cirrus, a more compact, more affordable sedan, yet every premium inch a Chrysler. The elegantly appointed Chrysler LHS is manifestly the most elegant Chrysler ever to speak in the unpretentious voice of sheer luxury. The masterfully engineered Town & Country has been garnering accolades for improved engineering since it introduced luxury to the minivan



Sebring LXi Coupe



Cirrus LXi



Chrysler 300M

nearly a decade ago. And Sebring (the convertible engineered *to be* a convertible) offers more than enough room and style to be anyone's year-round primary car. The roadworthy pedigree of the impeccably mannered 300M thunders back to the fabled 300 letter series of the '50s and '60s. And the road-running audacity of the spirited Sebring Coupe belies an engineering triumph of interior volume over exterior dimension. The 1999 Chryslers... passionately conceived to overtake the ordinary. Designed, appointed, perfected, road-proven. Engineered to be Great Cars.



Since the time of printing, some of the information you'll find in this catalog may have been updated. Ask your dealer for details. Some of the equipment shown or described throughout this catalog is available at extra cost.

CHRYSLER 300M



WHEN CHRYSLER DARED TO INTRODUCE the first 300, America's then-most-powerful production car, it was named after a robust, 300-horsepower Hemi® engine that in other coachwork had raced successfully at the Carrera PanAmericana and the 24 Hours of LeMans. Those 300s then took to the speedways and bullrings of NASCAR with great results. In the following decade, 300 designers dared to be different with grand-touring styling, taut suspensions and four-speed manuals... a framework of performance that was filled to overflowing with luxuries befitting the advanced mechanics. Enter now the most sophisticated Chrysler sedan, ever. The 1999 300M. Who dares wins.

THE SOUL LIVES ON, EVEN THOUGH

THE TECHNOLOGY has dramatically improved after 44 years. Presenting the 1999 Chrysler 300M. This is the most sophisticated sport sedan we've ever engineered — and a cutting-edge contemporary successor to the **brute force legacy** established by our fabled letter series 300s of the mid century. Now, as the millennium nears, Chrysler **design and engineering** excellence provides a modern interpretation of these classics for today's more demanding driving enthusiasts.

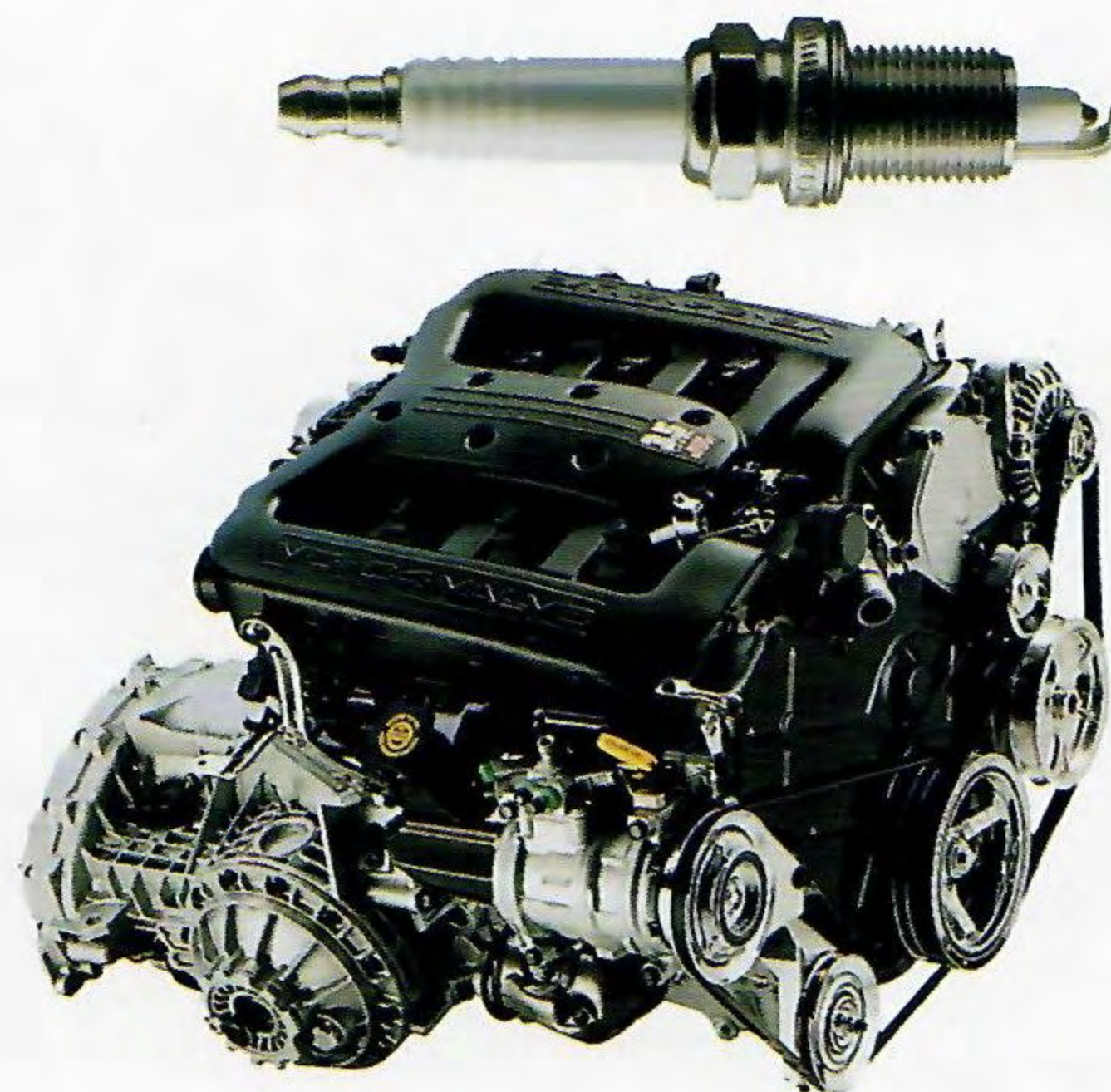

This all-aluminum, SOHC 24-valve 3.5-liter High Output V6 gets 100,000 miles between tune-ups* and produces 253 horsepower* at 6,400 rpm.

*Maintenance needs vary depending on vehicle use and driving conditions. See Owner's Manual for details.

*When using midgrade fuel. This engine will operate safely and satisfactorily on regular unleaded fuel.



Here is a surprisingly quick and astonishingly agile driver's car—a true executive express.

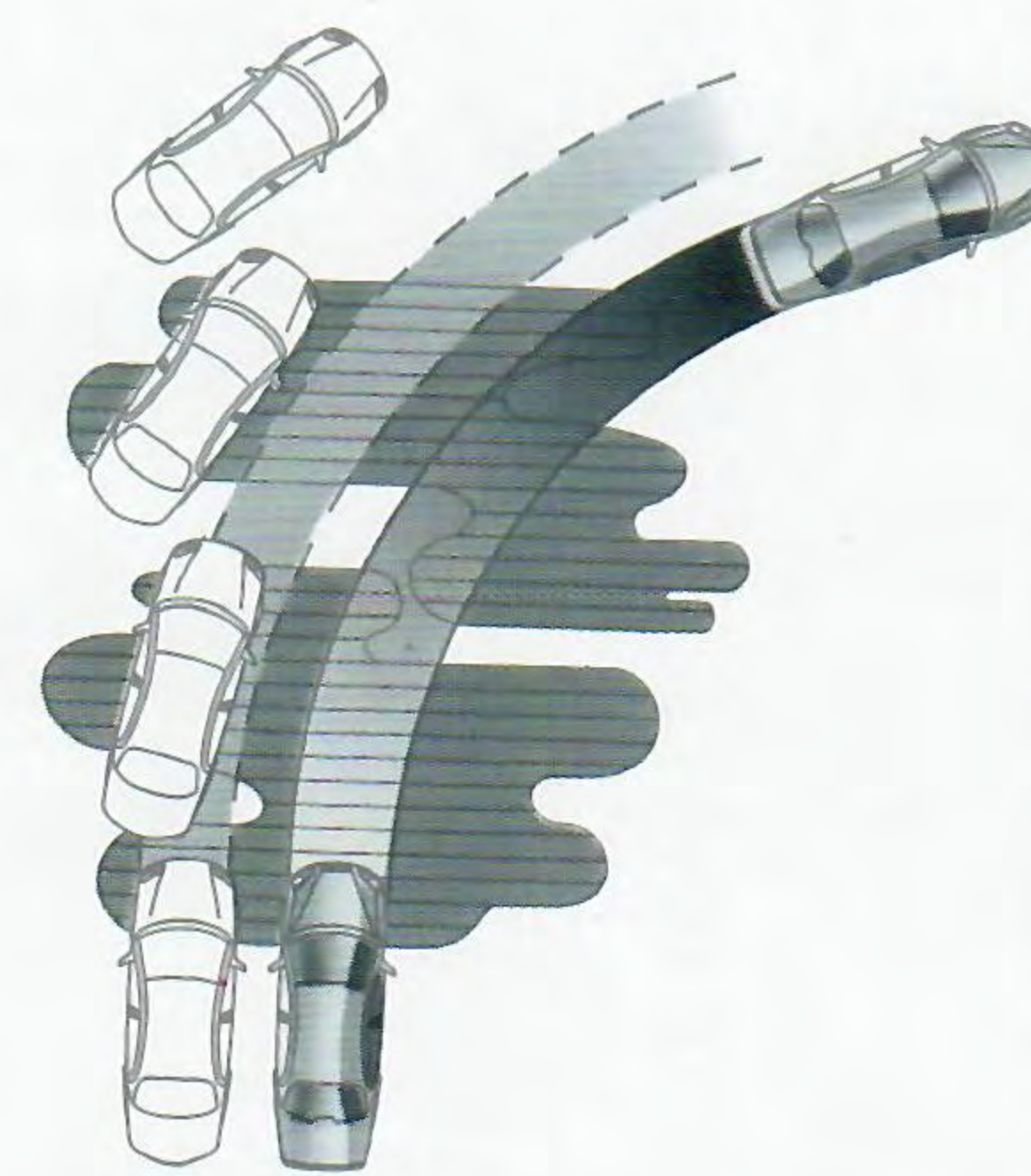

Four-wheel discs help reduce fade and the antilock brake system helps 300M steer through slick weather emergencies.

Tighter suspension tweaks in the available Performance Handling Group package boost 300M's cornering power to the max. Bright, 16-inch cast aluminum wheels emphasize raciness.



AutoStick® provides the option of clutchlessly selecting all gear changes—or cruising effortlessly via a supersmart four-speed automatic with overdrive.



Chrysler 300M in Deep Slate Pearl Coat

CHRYSLER 300M

ELEGANT CARS THAT CARRIED BIG

STICKS is the way the original Chrysler 300s

are remembered. The elegance is multiplied with

the 300M, where the added luxury of 105.1 cubic feet

of **spacious interior volume**, unimaginable

by earlier people-packaging limitations, is matched

only by the hushed-but-throaty passage of 300M

across the two-lane blacktops you'll find yourself

driving for the sheer exhilaration they provide.

Here is **total interior accommodation** in an

integrated environment. Basic, easily memorized

shapes and soft-touch surfaces convey quality

with an overriding impression of handcrafting.

Leather trim is standard, of course.

So fully equipped is 300M that only four major options are available: Performance Handling Group; power moonroof; 17" chrome aluminum wheels; Infinity II Spatial Imaging™ Sound System.

SELECT STANDARD FEATURES

- Low-Speed Traction Control
- Fully independent suspension
- Quad-halogen headlamps
- Electronic speed control
- Solar-control glass
- Preset seat/radio/mirror memory for two drivers
- Height-adjustable steering column
- CFC-free air conditioning with automatic temperature control
- Vehicle Theft Security System monitors doors, trunk, key cylinders
- Heated, eight-way power front seating
- Huge, 16.8-cubic feet cargo capacity
- Trunk cargo net

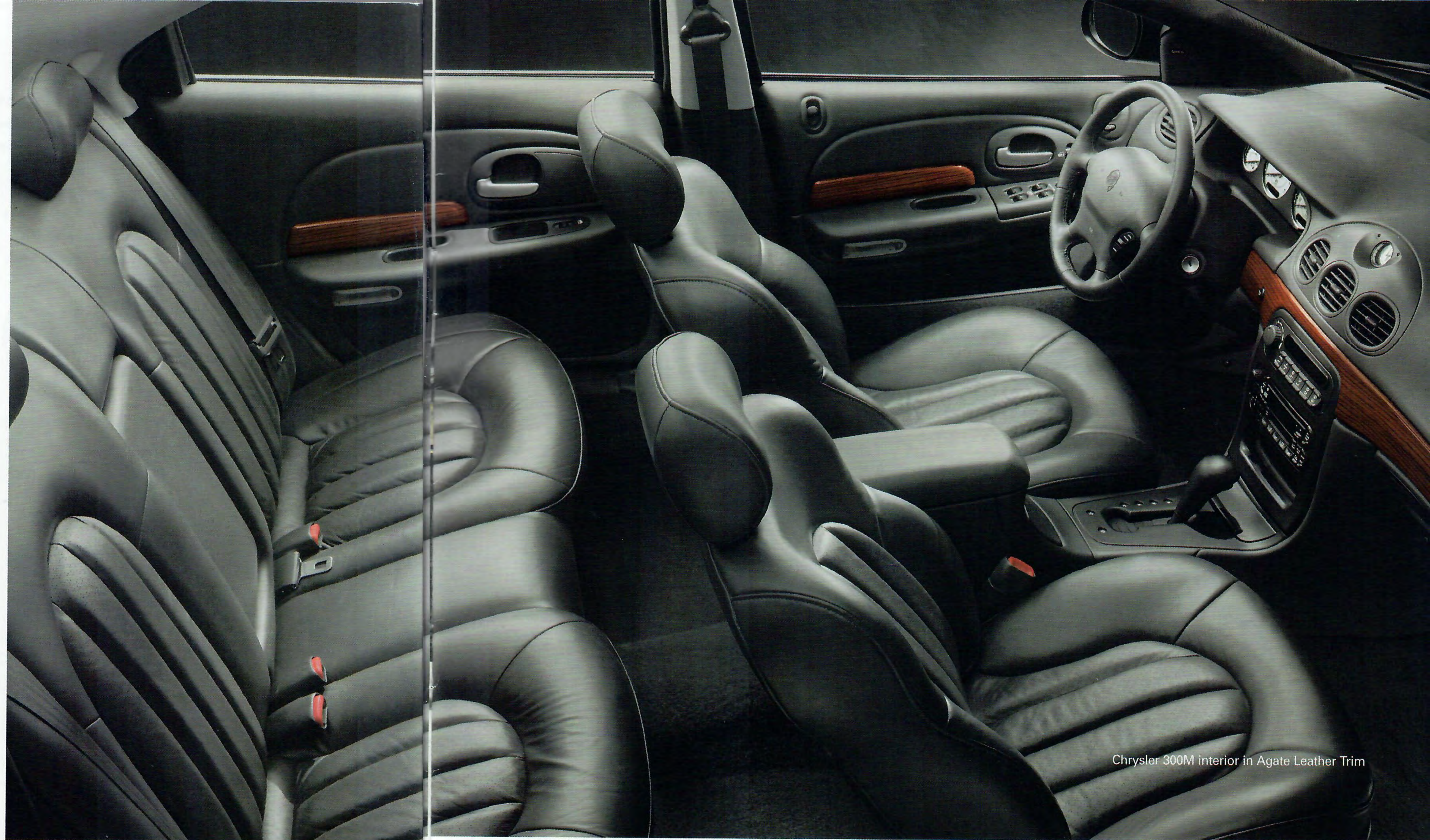

Chrysler 300M interior in Agate Leather Trim

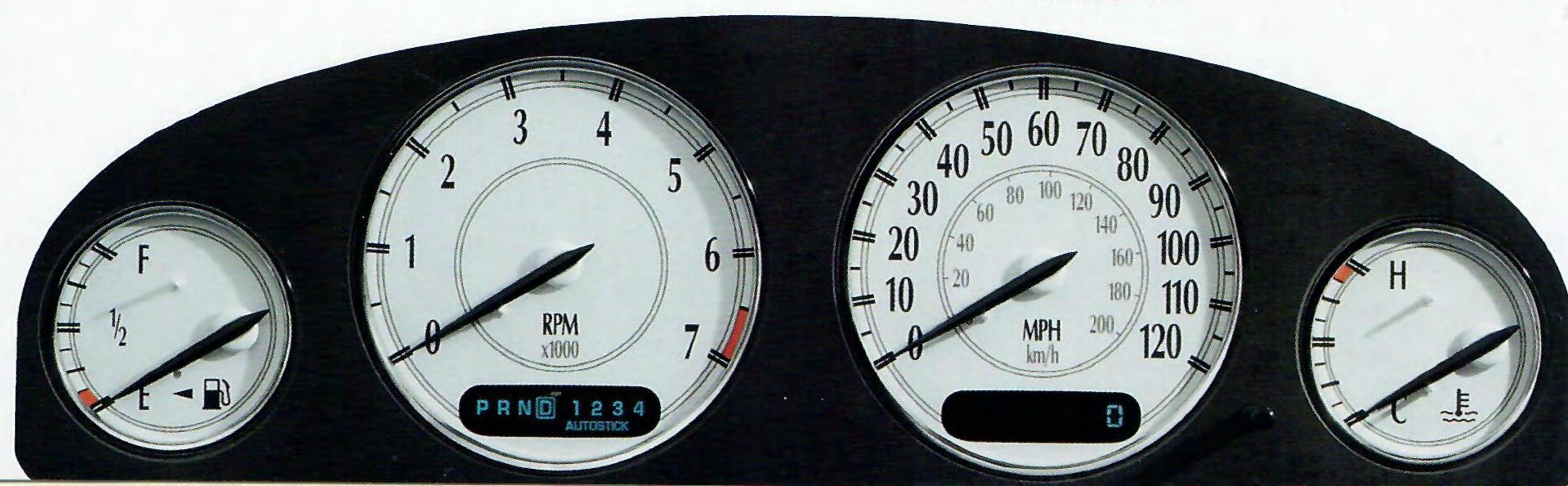

Gauges' black graphics and creamy white faces are reminiscent of handcrafted, Swiss-made watches.



Available Infinity II Spatial Imaging Sound System™ has 320 watts, with 11 speakers in nine locations.

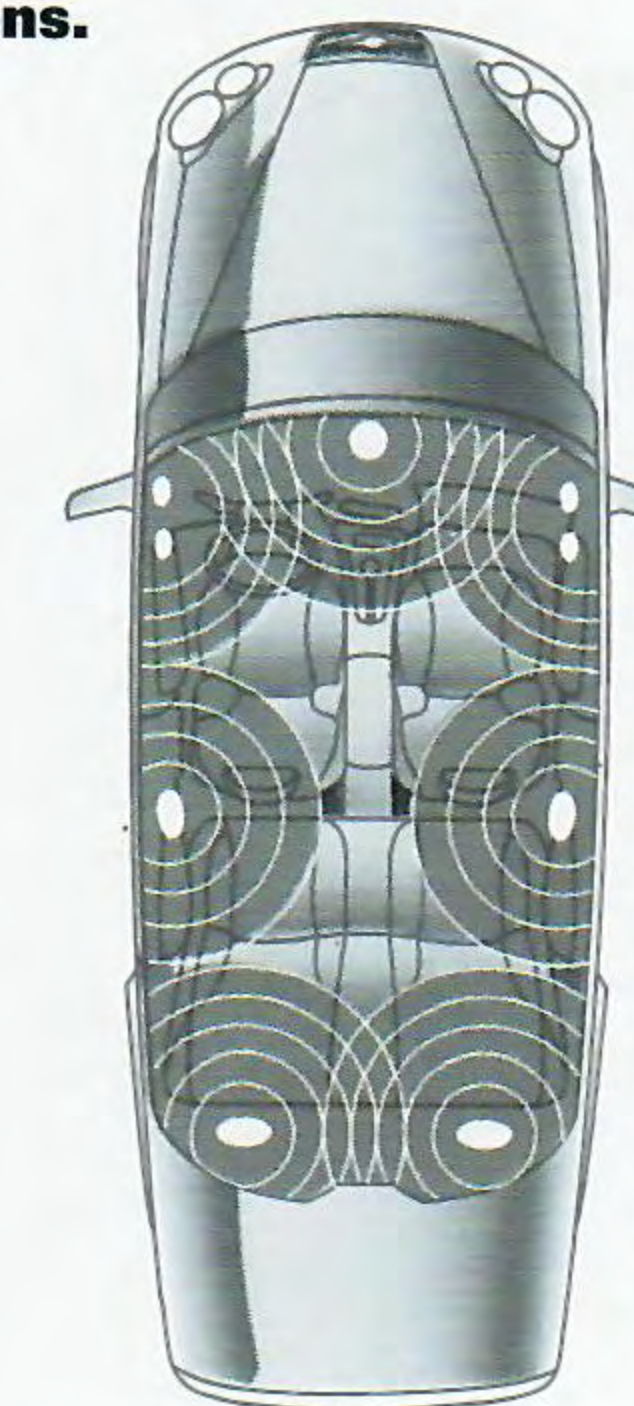

Convenient central overhead console has dual map lamps, compass, outside temperature, trip computer, and HomeLink® Universal Transmitter.



Beautifully handcrafted leather trim provides rich contrast with 300M's nicely simulated burl wood.

CHRYSLER LHS

THE MOST DISTINCTIVE AND BEST-BRED LUXURY CHRYSLER EVER.

The all-new 1999 Chrysler LHS is the embodiment of everything we've learned about the art and science of engineering great cars. One look will tell you that we've

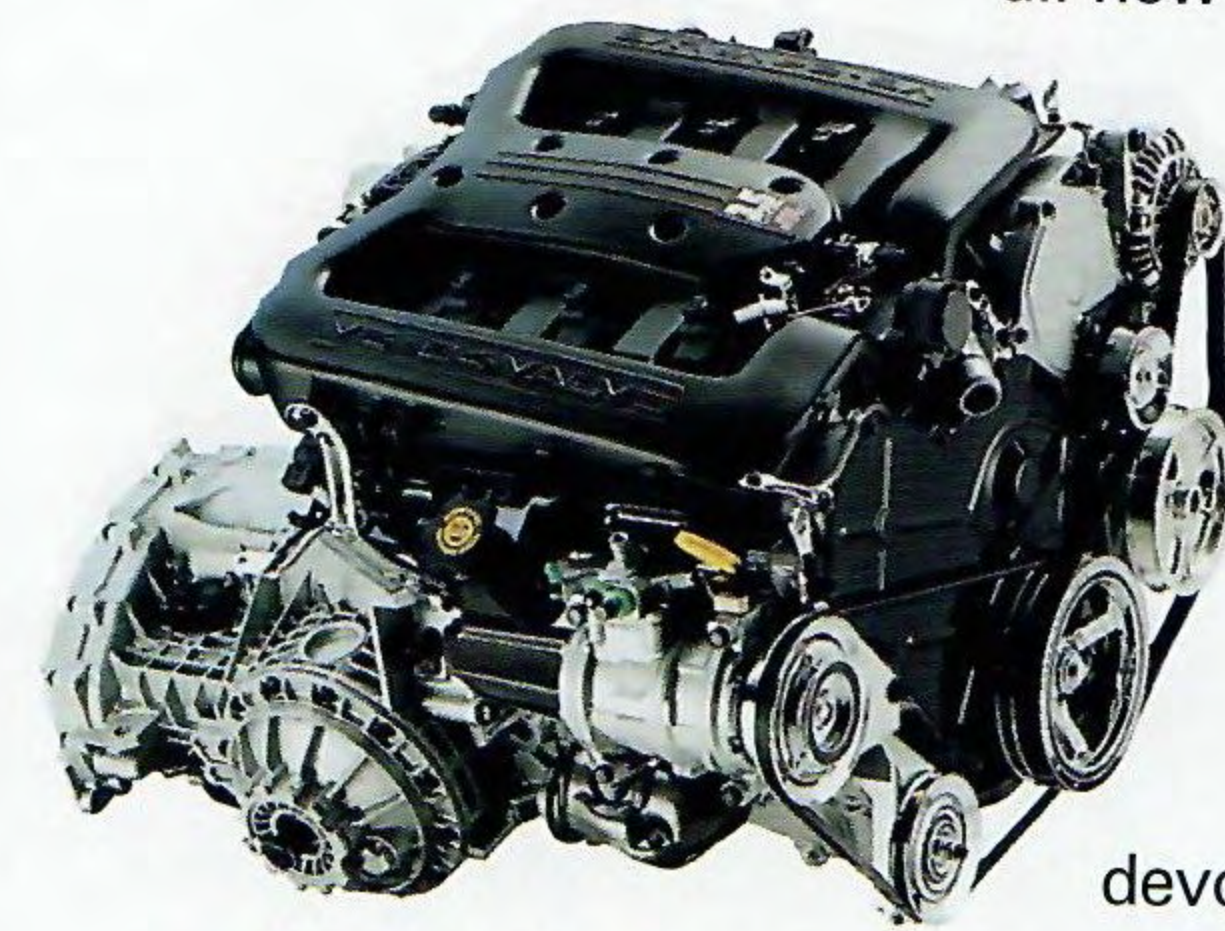

devoted quite a bit of attention to the concept of luxury. We've carefully analyzed the subtleties of elegance, comfort and performance to establish a blueprint for the sum and substance of LHS' premium driving experience. The result is an American luxury sedan of the highest caliber, shaped by the eyes of artists, but crafted under the expert scrutiny of engineers.

Elegant styling is right before your eyes in the sophisticated LHS instrumentation.



High-performance four-wheel disc antilock brake system provides positive, consistent pedal feel, plus increased fade resistance.

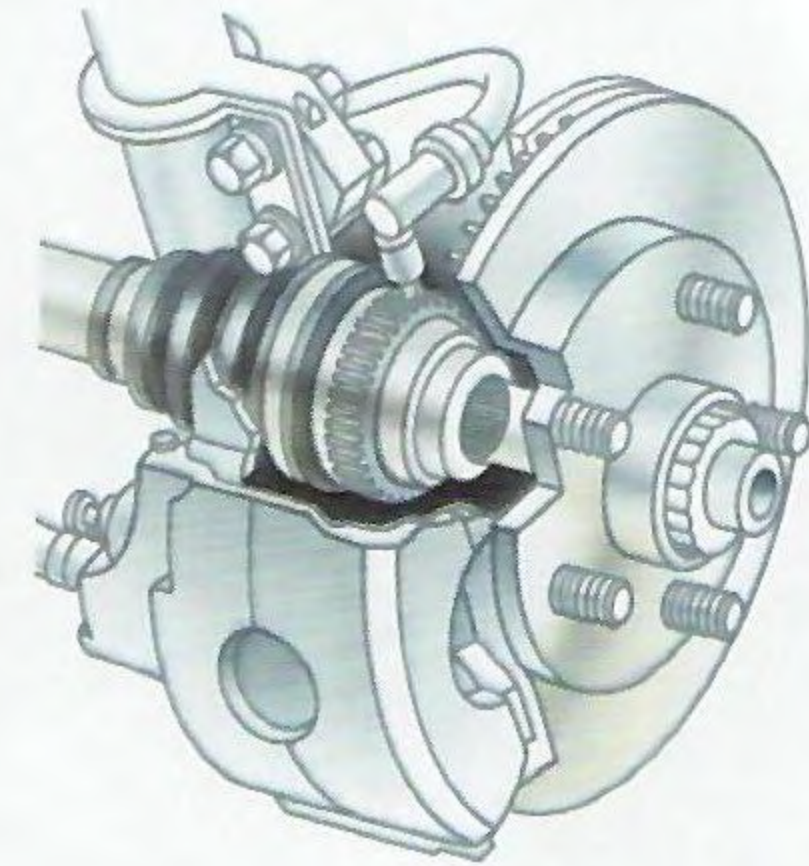

A refined rear-suspension aluminum crossmember produces a low-noise path transmission for a very quiet passenger compartment.



Designed with advanced computers, LHS' Unibody shell provides 37 percent greater torsional rigidity and 46 percent greater bending stiffness than prior models.

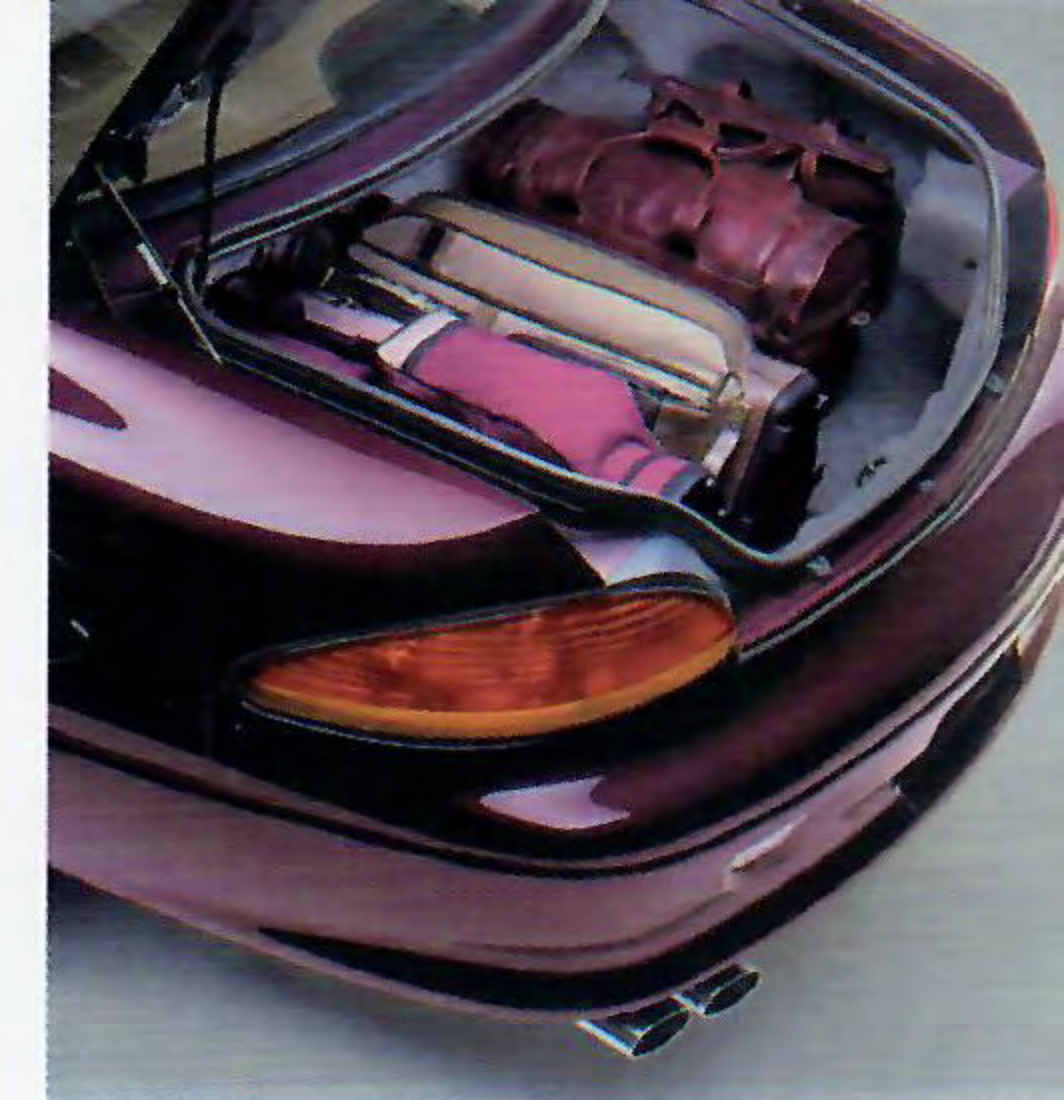

Wide open and roomy. 18.7 cubic-foot trunk features specially designed hinges and props to prevent intrusion on luggage capacity when closed.



Chrysler LHS in Champagne Pearl Coat

CHRYSLER LHS

CAB-FORWARD ROOMINESS WITH AN AMBIENCE OF ELEGANCE.

From the meticulously finished instrument panel to the rich,

supple, leather-trimmed seating, you'll see

that Chrysler LHS' interior elevates the

science of automotive ergonomics

to an art form. The exclusive cabin calls to mind the days of fine custom bodies—not production vehicles. Within the spacious and quiet 107.3 cubic-foot environment, rich appointments such as woodgrain accents, chrome and soft-touch surfaces lend an air of refined luxury. The detailed stitching of the heated, eight-way power driver and front-passenger seats makes them look handmade. And a **personalized memory system** recalls the seat positions, outside mirror settings, even radio station presets for two drivers.



Center analog clock lends the distinguished look of a fine timepiece.

So many features are standard on LHS (a partial list is below) that only a few major options are available.

SELECT STANDARD FEATURES

- Low-Speed Traction Control
- Variable-assist speed-sensitive power steering
- Smooth four-speed electronically controlled automatic transaxle
- Remote keyless entry
- New battery-saver feature
- New rear window integrated radio antenna
- Available power moonroof with express-open feature
- Air conditioning with automatic temperature control
- Trunk cargo net
- Rear armrest with storage and dual cup holders
- Power door locks, windows and trunk release

All controls and instrumentation are designed to minimize distraction while promoting an easy interactive relationship between car and driver.



Chrysler LHS leather-trimmed interior in Camel



Overhead console contains: map lamps, compass, outside temperature, trip computer, and HomeLink® Universal Transmitter.



Sentry Key™ Engine Immobilizer offers additional protection against theft.

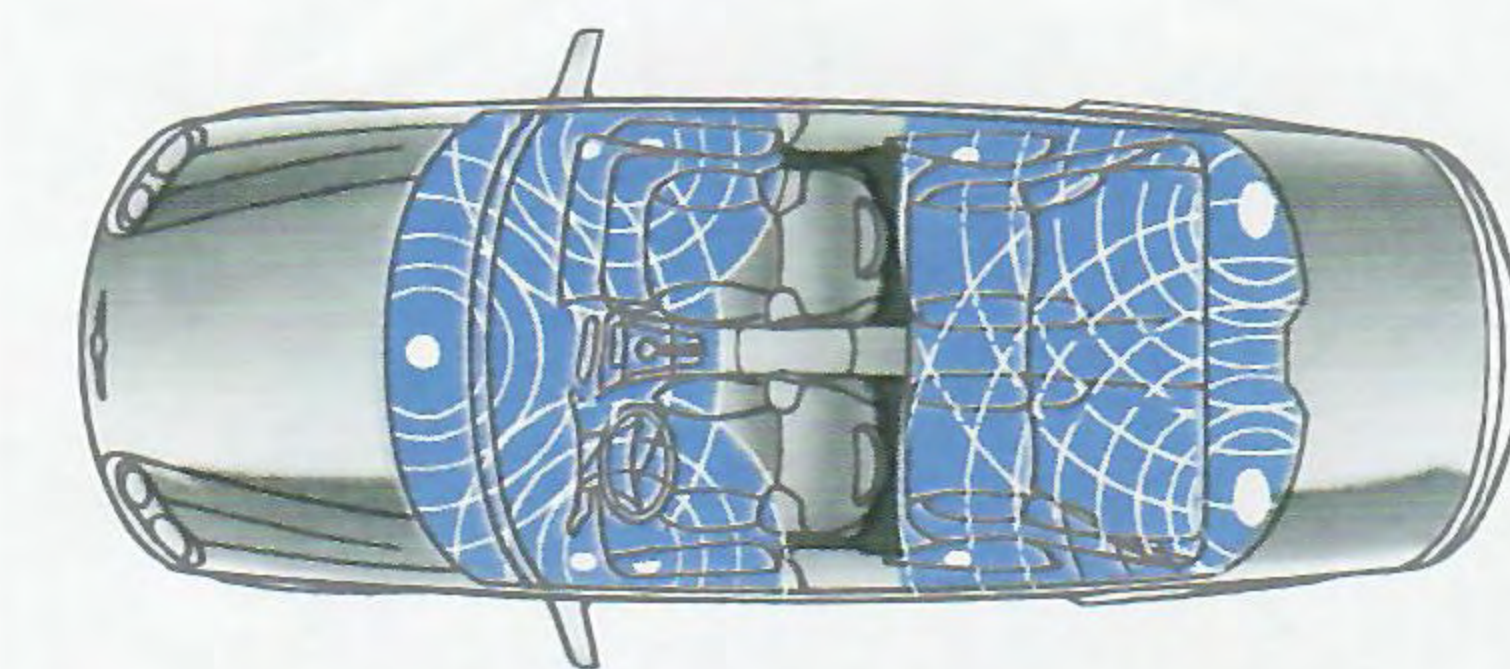

An available 320-watt Chrysler/Infinity Spatial Imaging™ Sound System, specifically designed for the acoustics of the interior, fills the cabin's silence with breathtaking presence.

Trunk pass-through easily allows long objects to extend from the trunk into the passenger compartment.

Properly secure all cargo before transporting.

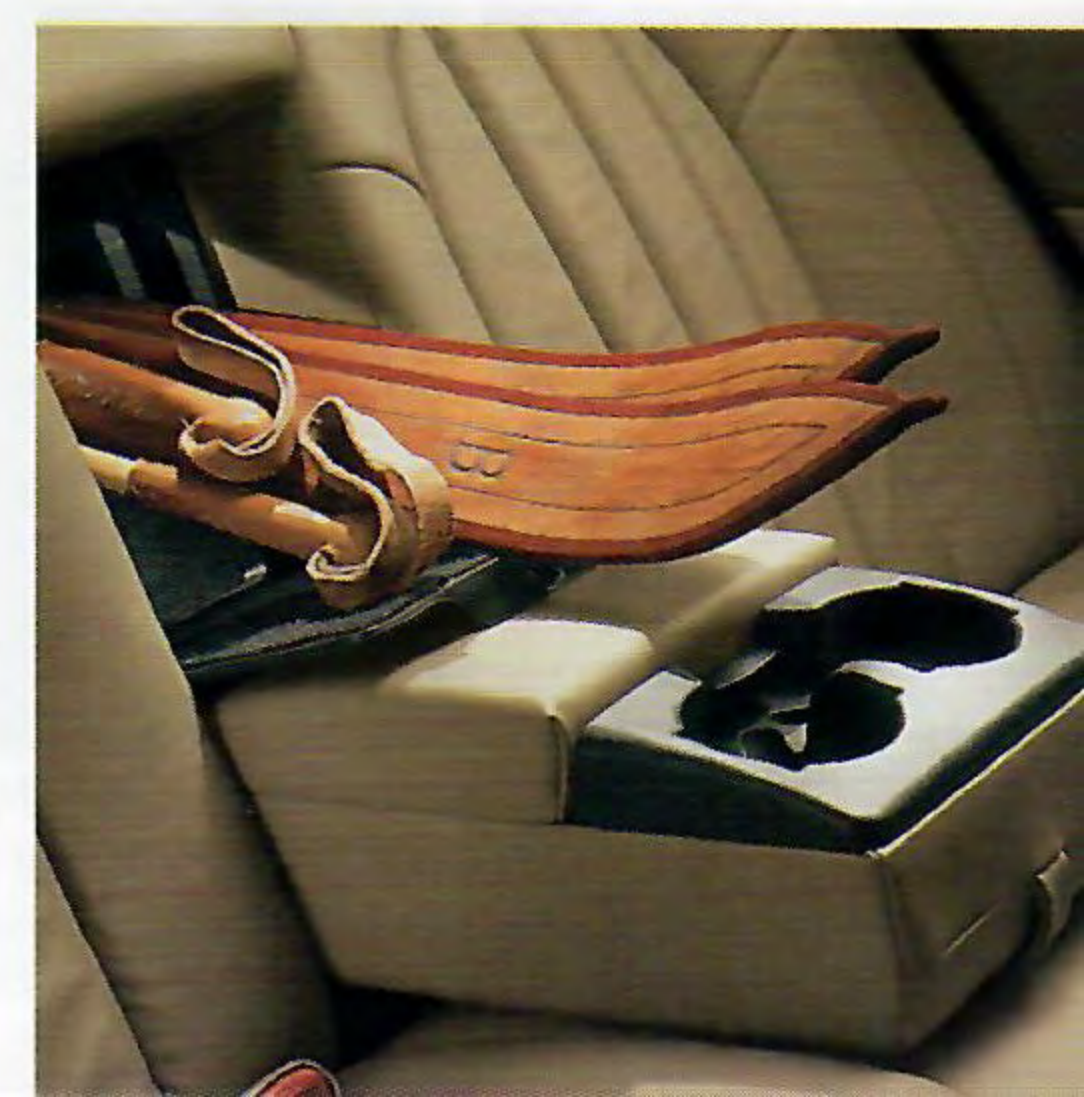

ALLURING OUTSIDE AND SPACIOUS

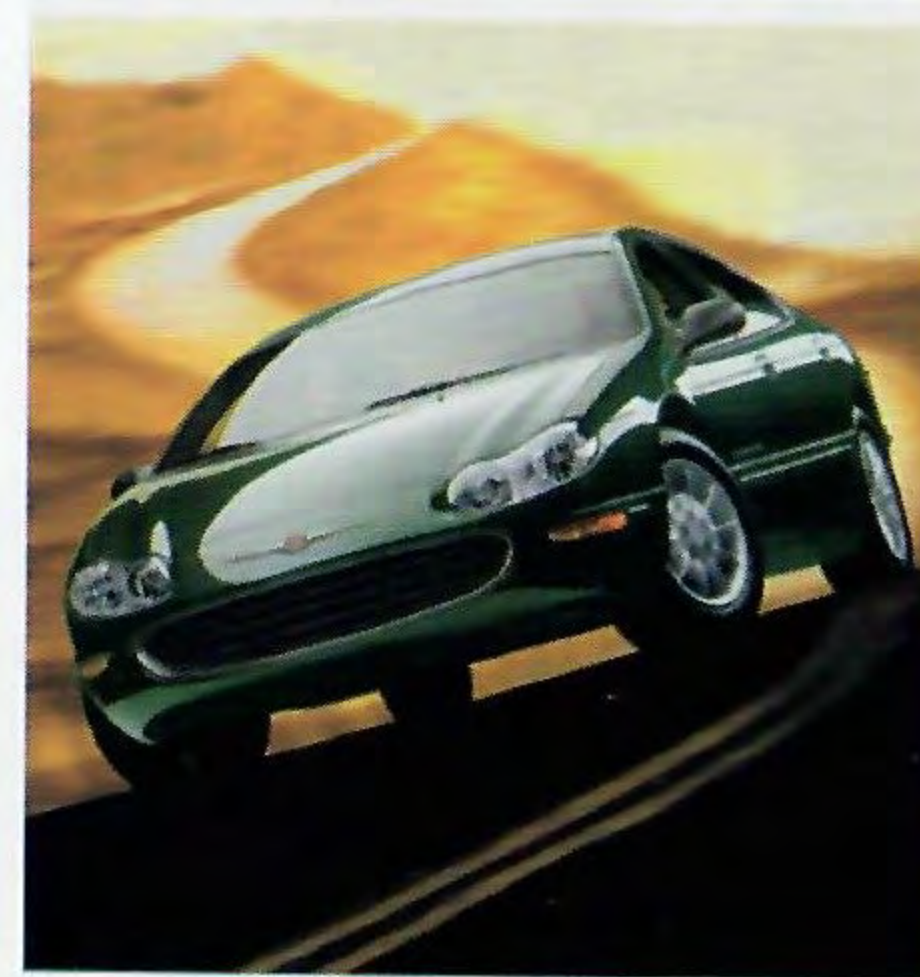

INSIDE. Agile afoot and powerfully efficient. In a word, sophisticated... a careful **blending of looks and legacy** that combines sleek expressive styling with a

heritage of innovative engineering. The result is Concorde, the next generation of Chrysler's acclaimed cab-forward design. The evolution of that design gives Concorde **its stunning looks**, a silhouette sensuously styled in a single, continuous, sculptured line. But it is the legacy of Chrysler engineering that provides Concorde-on-the-road with **its zest and agility**, behaving for all the world like a spirited coupe. Tasteful design. Practical engineering. Refined.

The 2.7-liter 24-valve V6 with dual overhead cams, standard on Concorde LX, delivers 200 horsepower.



Concorde LXi has a 3.2-liter 24-valve V6* that generates 225 hp. Both engines feature leak-free design and 100,000-mile spark plugs:

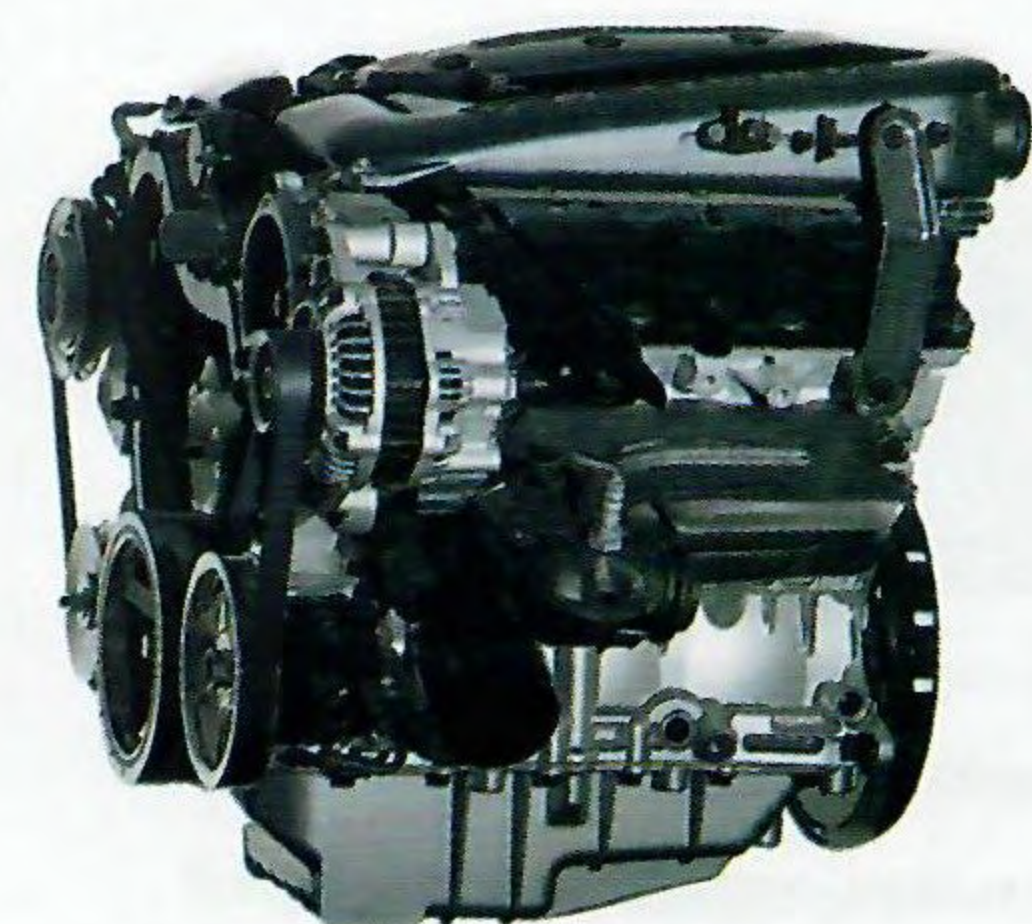

Chrysler Concorde
"Best Premium Midsize Car in Initial Quality"
— J.D. Power and Associates†



Concorde LXi in Champagne Pearl Coat

Optic-free lenses and high-powered reflectors contribute to Concorde's world-class halogen illumination.

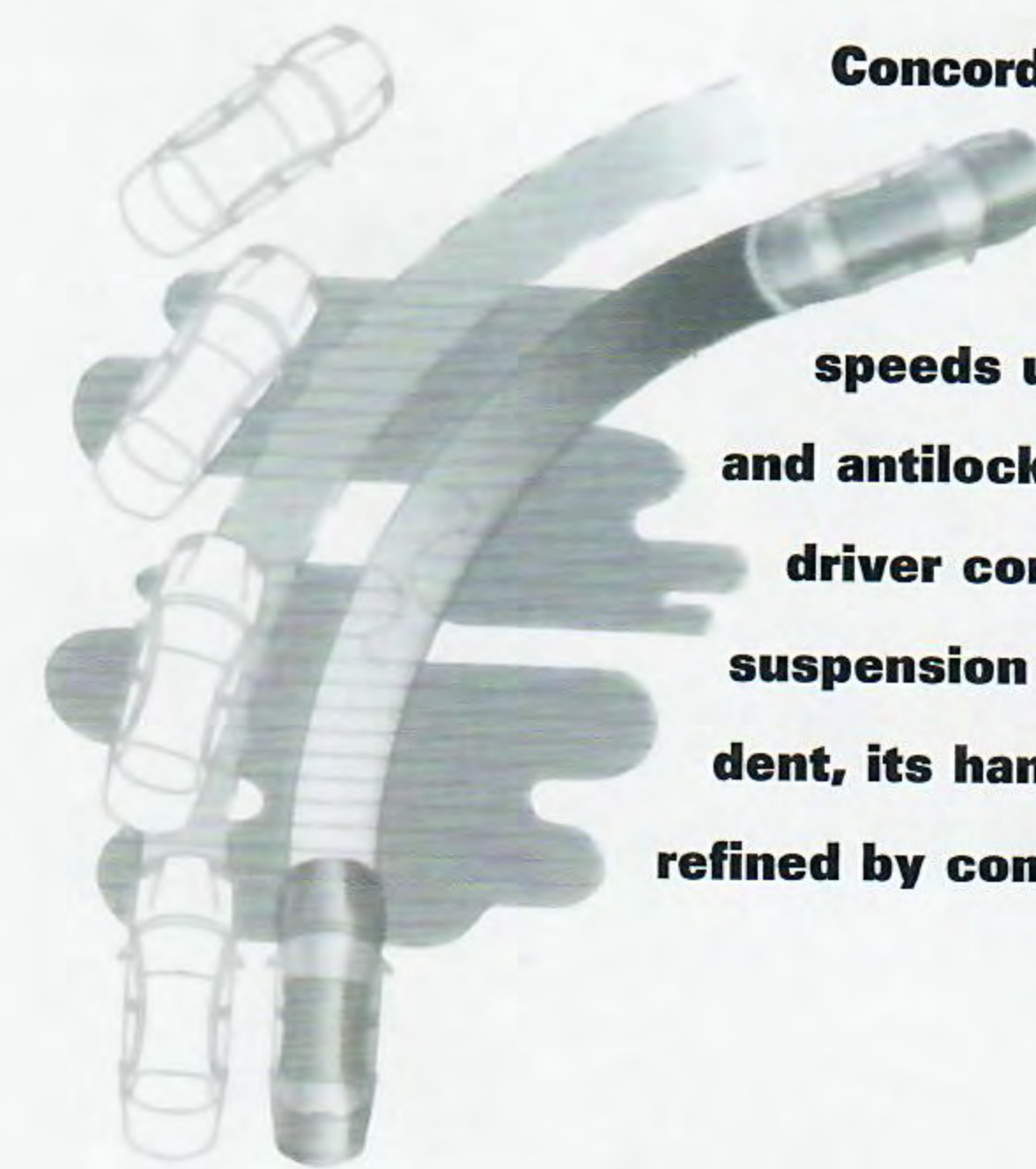

Concorde LXi's Low-Speed Traction Control (functioning at speeds up to 35 mph) and antilock brakes improve driver control. Concorde's suspension is fully independent, its handling response refined by computer modeling.



*Required with LXi Package 24F at extra cost.

†Maintenance needs vary depending on vehicle use and driving conditions. See Owner's Manual for details.

‡The Chrysler Concorde was the highest ranked premium midsize car in the J.D. Power and Associates 1998 Initial Quality Study 2SM Study based on a total of 58,117 consumer responses indicating owner reported problems during the first 90 days of ownership.

CONCORDE COMES WITH A WHOLE

LOT OF COMFORT. And much of it is standard,



A Chrysler/Infinity Spatial Imaging™ Sound System with nine speakers in seven locations is available on Concorde LXi.

including: air conditioning, keyless entry, illuminated visor vanity mirrors,

electronic speed control, power exterior mirrors, power windows with driver's one-touch-down feature, and speed-sensitive power door locks. The luxury of a five-passenger **leather-trimmed**

interior, with eight-way power front bucket seats and leather-wrapped steering wheel and shift knob, is included on Concorde LXi, along with

automatic temperature control to ensure an ideal all-weather comfort level. Unique interior color tones, marked by a dark upper area over a light

lower, richly enhance Concorde's feeling of spaciousness. Woodgrained accents provide a

warm welcome. Six-passenger seating is available with the addition of a 50/50 split-bench front seat.



LXi's standard overhead console, with map lamps, compass, temperature and trip computer functions, is also available on Concorde LX.



Trunk pass-through, built into the center of the rear seat-back, provides access to the massive 18.7-cubic-foot trunk. Fold-down armrest has storage space and two cup holders.

Properly secure all cargo before transporting.



The soft-touch urethane surface of the upper instrument panel is an industry first. Courtesy lamps feature automatic theater-style dimming.

SELECT STANDARD FEATURES

- Two-speed windshield wipers with speed-sensitive variable intermittent mode
- Solar-control glass
- Remote keyless entry
- Fully independent touring suspension
- Power trunk lid release
- Trunk cargo net

LXi ADDS

- Leather-trimmed seating with 8-way power front seats
- Automatic temperature control
- 3.2-liter 24-valve V6 engine
- Vehicle Theft Security System with Sentry Key™ Engine Immobilizer
- Four-wheel disc antilock brakes and Low-Speed Traction Control
- 16" aluminum wheels
- Overhead console with trip computer and HomeLink® Universal Transmitter



Concorde LXi leather-trimmed interior in Camel

CIRRUS LXi

SELECT STANDARD FEATURES

- Four-speed automatic
- Speed-sensitive rack-and-pinion power steering
- Four-wheel fully independent modified double-wishbone suspension
- Four-wheel disc antilock brakes
- Rail-thru construction
- Child-protection rear door locks
- Air conditioning with rear-seat outlets
- Electronic speed control
- Security Group with remote keyless entry, illuminated entry, panic alarm and headlamp time delay
- Height-adjustable steering column
- Power windows with driver's one-touch-down feature
- Cargo net

FULLY LOADED LUXURY.

It's obvious once you sit in a Cirrus that it is every inch a Chrysler.

From the feel of the luxurious no-extra-cost

leather-trimmed seats, to the eye-catching style

and roominess of its cab-forward design, to the

green-light go power of its spirited **2.5-liter V6***

it's clear that Cirrus has benefited from 75 years of

Chrysler engineering heritage. Best of all, Cirrus

offers many luxury-car features, including integrated

fog lamps, antilock brakes, air conditioning, heated

power exterior mirrors and chrome wheel covers as

standard equipment. It's Chrysler's way of saying

that extras shouldn't cost extra.



Chrysler Cirrus
"Best Entry Midsize Car in Initial Quality"
— J.D. Power and Associates¹



Cirrus LXi in Champagne Pearl Coat



Cirrus' potent power comes neatly packaged in the 2.5-liter 24-valve V6* under its hood.

Highway power and a refined ride are standard on Cirrus.

*Built by Mitsubishi Motors Corporation.

¹The Chrysler Cirrus was the highest ranked entry midsize car in the J.D. Power and Associates 1998 Initial Quality Study 2SM Study based on a total of 58,117 consumer responses indicating owner reported problems during the first 90 days of ownership.

The spacious, elegantly outfitted Cirrus LXi interior affords the driver control and comfort within easy reach. A six-speaker system outputs dramatic sound.



Stowing large, bulky items in the trunk is no problem thanks to Cirrus' standard folding rear seatback.

Properly secure all cargo before transporting.

No-extra-cost leather-trimmed interior adds luxury and a touch of elegance to Cirrus LXi's spacious 95.9 cubic-feet of cabin space.



SEBRING CONVERTIBLE

TOP UP OR TOP DOWN, Sebring Convertible

provides year-round freedom of movement (not to mention freedom from the routine).



Sebring is designed **to perform**

Sebring's cab-forward design brings contemporary styling and comfortable room for two couples.

admirably in any season... and more smoothly than the convertibles you may remember. That's because Sebring's body rests on rail-thru construction, engineered to quiet the ride and minimize interior noise and vibration. Standard is a 2.5-liter 24-valve V6 engine.* The Limited's available **AutoStick**[®] **shifter** offers an even more fun-to-drive alternative, allowing the driver to clutchlessly select gear changes or to cruise effortlessly via the four-speed automatic.

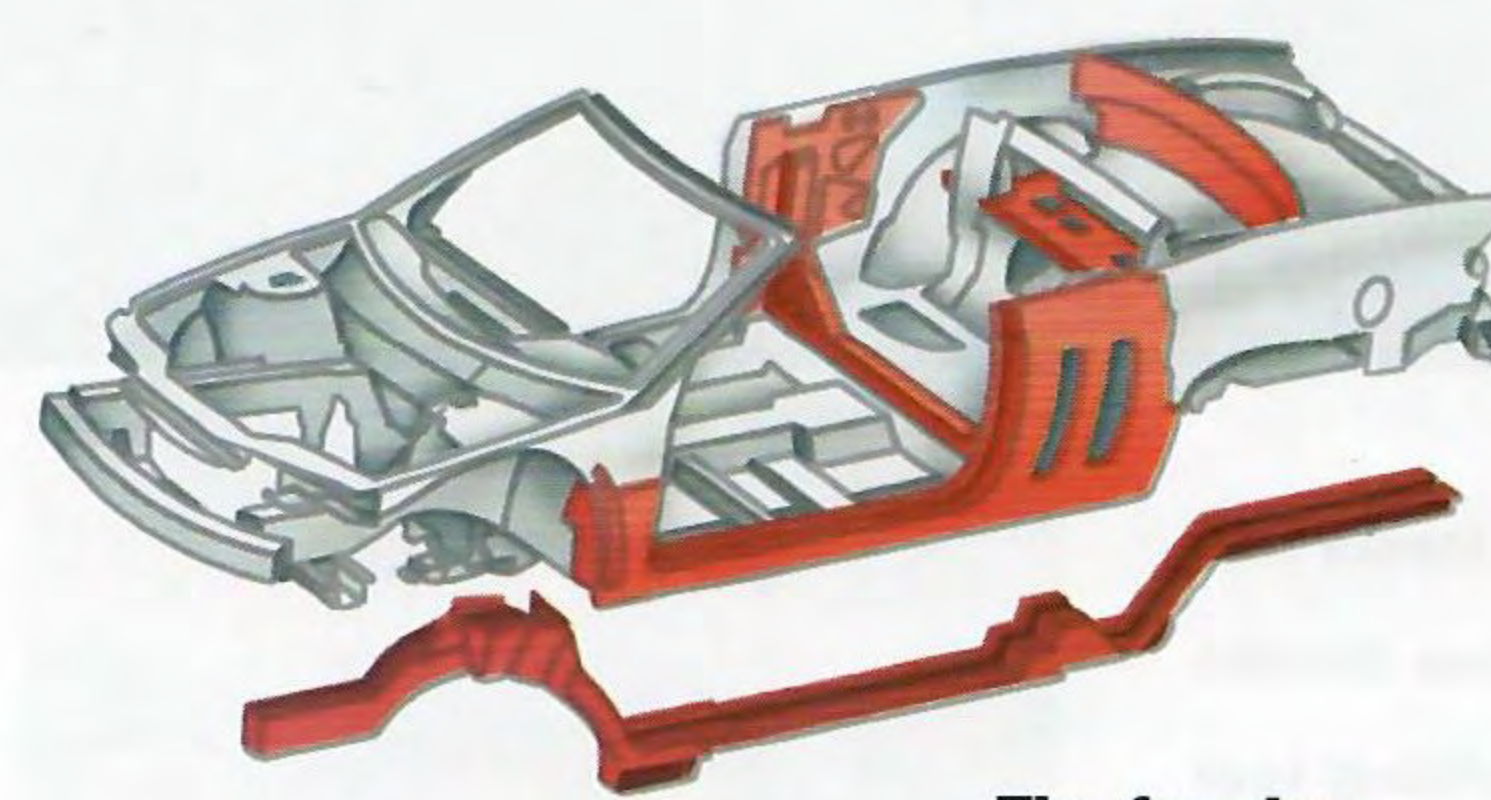

Sebring's double-insulated convertible top is designed to ensure year-round comfort.

The framing of rail-thru construction runs uninterrupted, front to rear, to provide the solid base that minimizes noise and vibration.

*Built by Mitsubishi Motors Corporation.
†Based on Strategic Vision's 1997 and 1998 Vehicle Experience Studies™ 31,521 ('97) and 32,191 ('98) Oct.-Nov. new vehicle buyers 200+ models after the first 90 days of ownership.



The AutoStick[®] shifter functions as an automatic—or as a manual for more precise driver control.

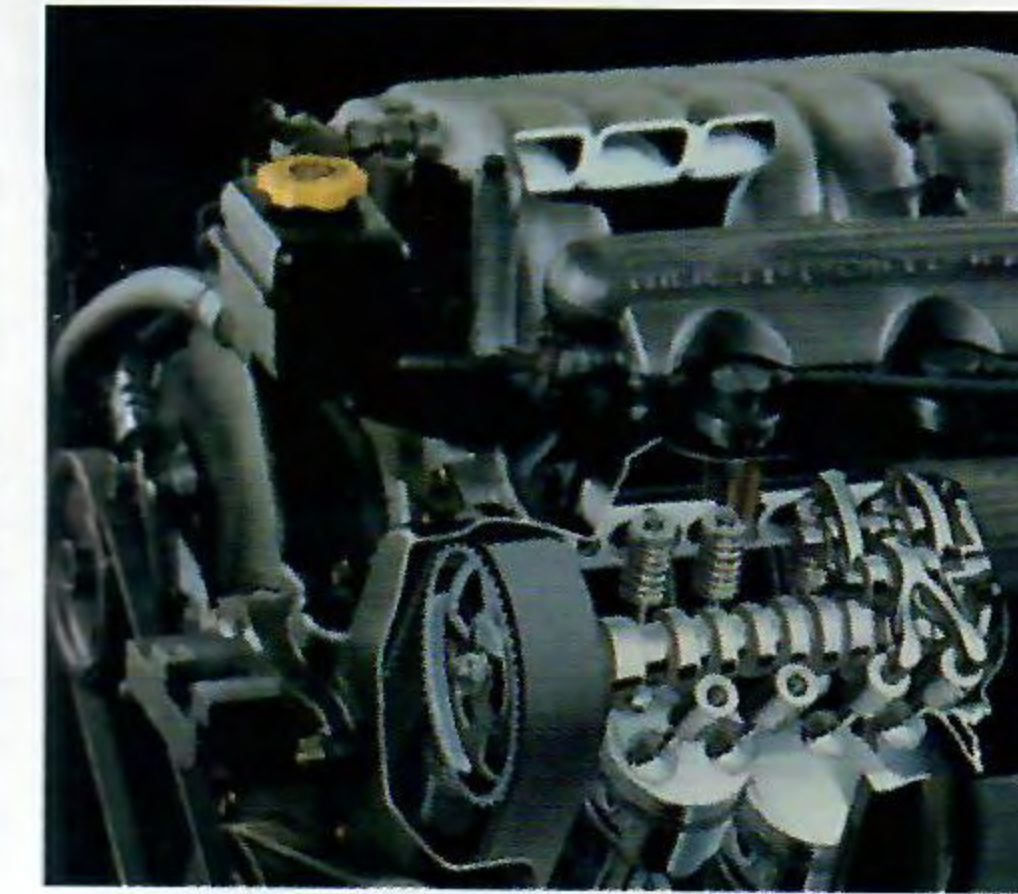

The high-combustion 2.5-liter, single overhead cam V6[†] engine provides Sebring's smoothly accelerating power.

Sebring's antilock brakes give drivers surer control, and its modified double-wishbone suspension system independently tunes the qualities of "ride" feel and "handling" feel.

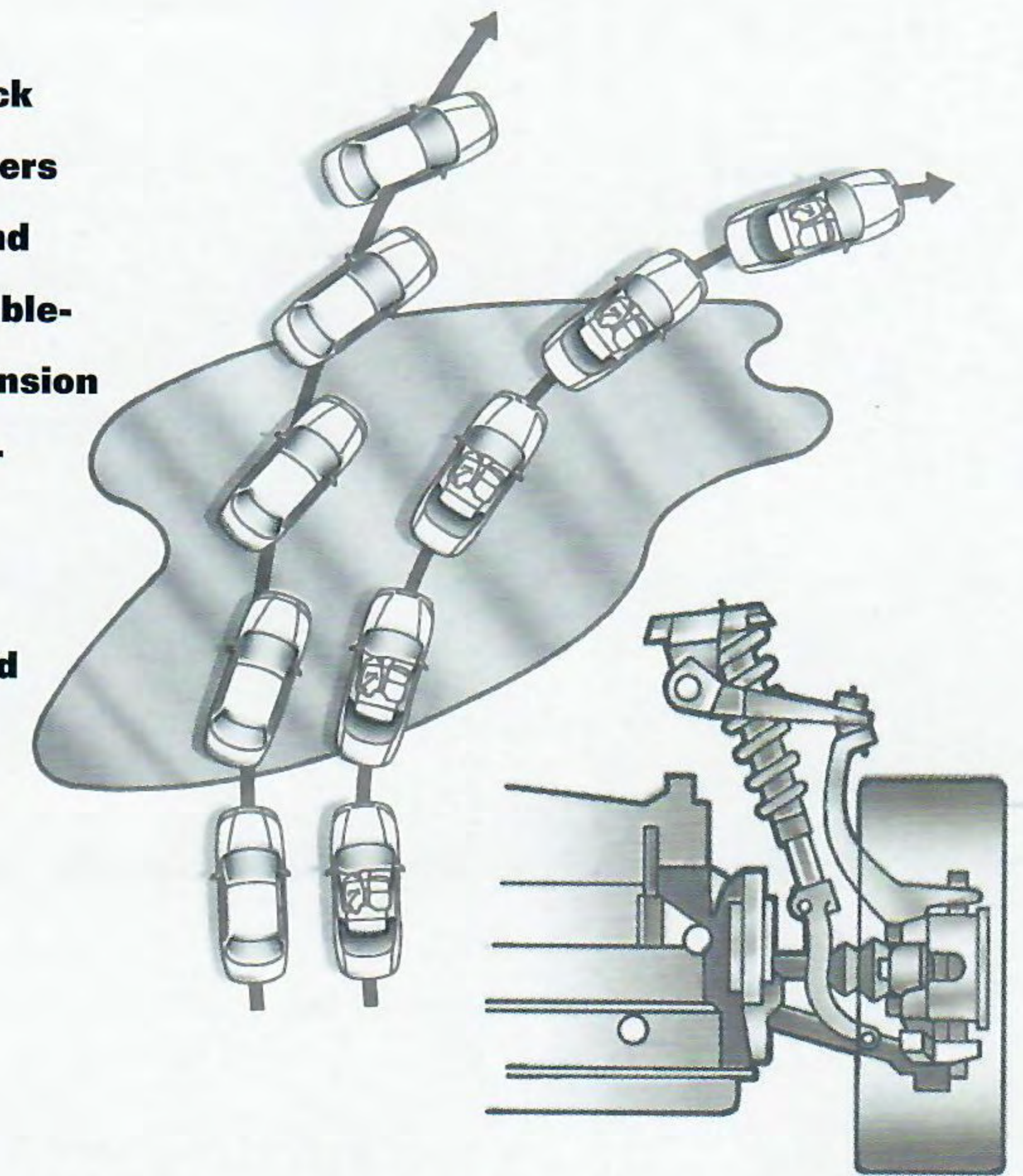

For the second consecutive year, Sebring Convertible has won Strategic Vision's (1998) Total Quality Award™ for "Best Ownership Experience" — convertibles under \$30,000 (Co-winner for 1998).



Sebring Limited Convertible in Champagne Pearl Coat

SEBRING CONVERTIBLE



Shoulder belts retract into the seatback and adjust automatically to the most comfortable height.

CAB-FORWARD ARCHITECTURE gives Sebring occupants something that's missing in most convertibles: freedom from squeeze. Chrysler engineers **maximized people space**, especially for the couple in the rear seat. That added comfort is just a small part of this car's inside story. JXi's six-way power driver's seat is leather-trimmed, and integral front-seat shoulder belts on all models adjust automatically to the best position for your height. Top-down cruising doesn't diminish the pure sounds produced by the **150 watts of power** delivered through the available Infinity® Sound System's six speakers. And the environment that keeps those sounds listenable was engineered *quiet*. A rigid body structure and extensive use of baffles, silencers and dampeners has produced a rarity of the road: **a quiet convertible.**

SELECT STANDARD FEATURES

- Power convertible top
- Air conditioning
- Color-keyed convertible boot
- Remote power trunk release
- Six-way power driver's seat
- Power heated exterior mirrors
- Illuminated entry
- Electronic speed control
- Speed-sensitive power steering
- Glass rear window with electric defroster
- Antilock brakes
- Remote keyless entry system with panic alarm and trunk release

JXi ADDS

- Leather-trimmed seating
- Traveler's display

Instruments are ergonomically correct. **Electronic speed control? Right under your thumb.**



Sebring Limited leather-trimmed interior in Agate/Camel (also available in Agate Sport)



Reading lamps are integrated into the rearview mirror. A day/night mirror that automatically dims the reflected glare of a following car's lights is also available.

Sebring's Top-Down Audio Equalization System maintains sound quality for a proper listening level on the road and is part of the available Infinity® Sound System with premium AM stereo*/FM stereo radio and cassette/CD combo. Also available for dealer installation is a separate Mopar dash-mounted six-disc CD changer with faceplate controls (factory installation available on Sebring Limited).



*Some AM stereo broadcasting may not be compatible with this radio.

SEBRING COUPE

SELECT STANDARD FEATURES

- Air conditioning
- Tachometer
- Speed-sensitive power steering
- Full-length center console with armrest and storage compartment
- Height-adjustable front shoulder belts
- Integral fog lamps
- Stainless steel exhaust
- Electric rear-window defroster
- Height-adjustable steering column

LXi ADDS

- Electronic speed control (optional on LX)
- Automatic electrochromic rearview day/night mirror with compass
- 17" cast aluminum wheels
- HomeLink® Universal Transmitter
- Body-color wheels on Caffe Latte and White models

THE TRIUMPH OF SEBRING goes well beyond its stylishly sporty appearance. Sebring is also an engineering triumph... of interior volume over exterior dimension. Those you pass by may see only a sport coupe that flashes a sleekly compact and smartly sculpted exterior, unaware of the 91.1 cubic feet of **expansive comfort inside**. Nor can the admiring observer feel the thrust of Sebring LXi's technically precise 2.5-liter, single overhead cam V6.* The feel of that power extends to a feel for the road, solidly supported by a fully independent, **double-wishbone suspension** that anchors turns and controls body sway. Sebring is the engineering triumph that meshes the un-coupe-like ability to *stretch out* with the on-road agility to *move out*.

*Built by Mitsubishi Motors Corporation.



Sebring LXi Coupe in Caffe Latte

• **Luxury abounds, in both appearance and convenience in Sebring LXi's interior.**

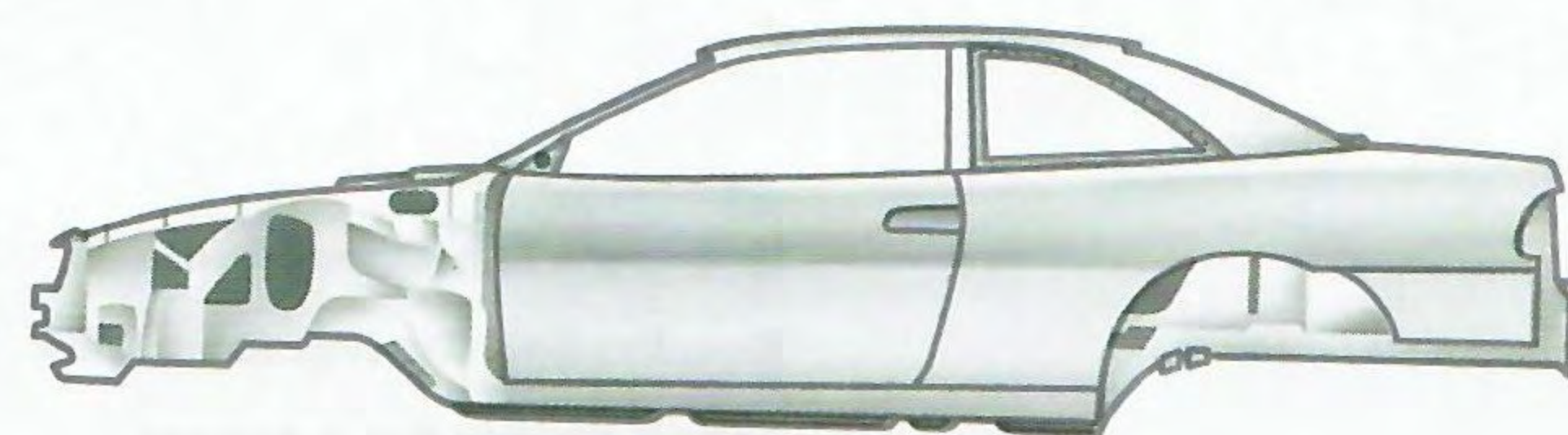

A rigid body structure translates to exceptional handling on the road.

Available Infinity® Sound System includes cassette/CD player combo and eight speakers.

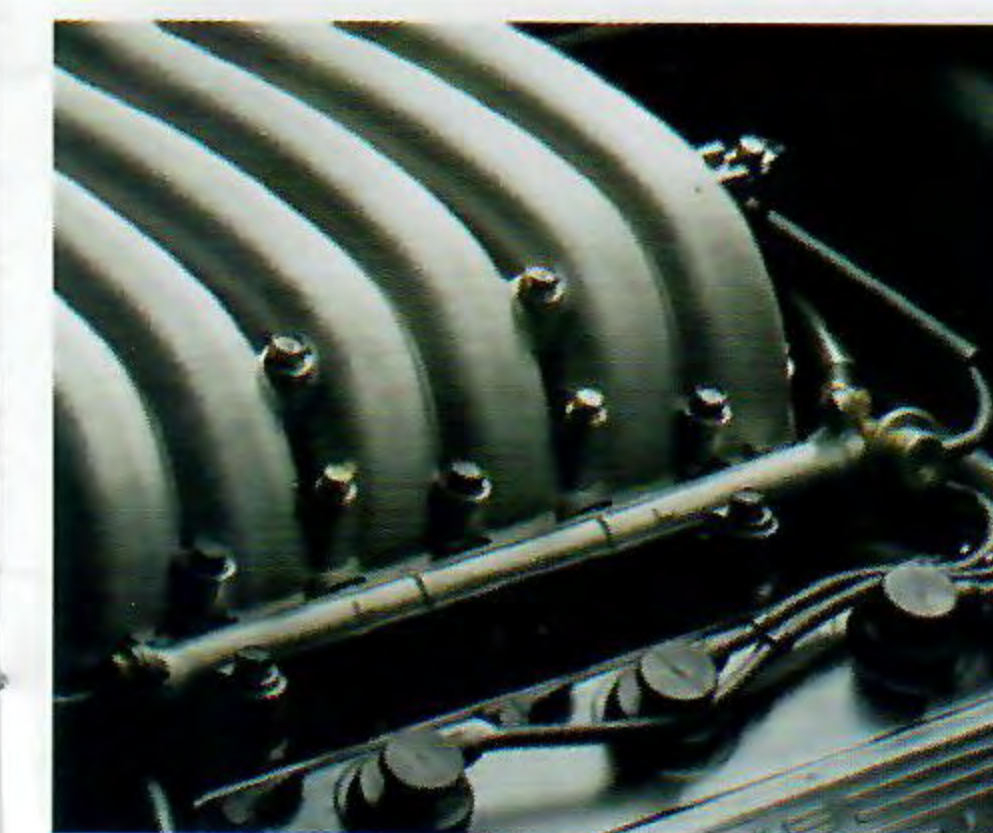
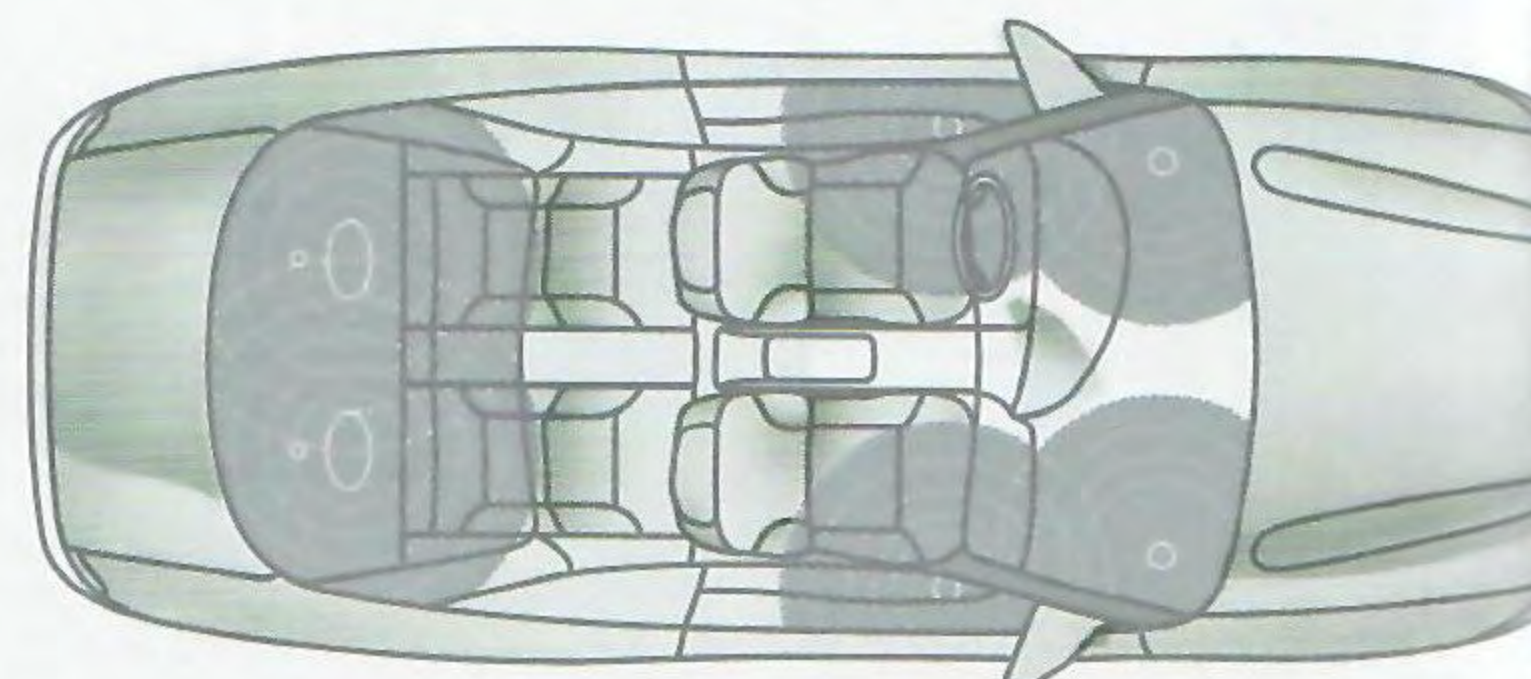

LXi's high-combustion 2.5-liter V6 produces 163 horsepower for responsive power and highway smoothness.

Pass-through expands Sebring's surprising interior room even more to accommodate hard-to-lug pleasure-trip gear.

Properly secure all cargo before transporting.



TOWN & COUNTRY LIMITED

TOWN & COUNTRY MEETS EVERY EXPECTATION of what a minivan should be:



Umbrella holder accommodates most parasols and offers close-at-hand convenience.



Eight-way power front seats, with driver-side memory, are leather trimmed and comfortably heated. Radio controls are on the underside of steering wheel.

quality engineering with comfort, room and versatility. And Town & Country Limited imposes no limits at all on those expectations. Limited is the ultimate Town

& Country, replete with an array of luxury features and appointments, safety and leading-edge technological innovation. The **Chrysler heritage of continuous refinement** has imbued Limited with excellent manners (a 3.8-liter V6 and effortless handling) as well as a luxury-car decor (Preferred Suede® leather-trimmed appointments on seven-passenger seating). **Uncompromised luxury and performance.**



Medallion chrome cast aluminum 16-inch wheel adds to Limited's luxury look.



Dual Zone Temperature Control offers separate air and heating temperature regulation for both front passengers.



With the available Trailer Tow Prep Group and the standard 3.8-liter V6, Limited can tow up to 3,500 pounds.



Limited's Preferred Suede® appointments complement the glove-soft leather-trimmed seven-passenger seating. Small items can be neatly contained in new front-seat cargo net.



Town & Country Limited in Champagne Pearl Coat

TOWN & COUNTRY LXi

LUXURY THAT SPEAKS IN AN UNPRETENTIOUS VOICE.

Combining expressive styling, choice performance and a **generously appointed**, distinctively spacious



Standard on LXi is a combined cassette/CD player and Infinity® 10-speaker sound system.

cabin, Chrysler Town & Country LXi is a minivan of sophistication, engineering

excellence and premium comfort. Motor not only in style, but in confidence with LXi's powerful **3.8-liter V6 engine** and available load-leveling suspension system. Bask in the comfort of LXi's eight-way power driver (with memory) and front-passenger seats and front/rear air conditioning. And whether your getaway plans include just one special someone or an entire clan, accessibility will never be a problem because LXi — like every Town & Country model — features seating to accommodate a crowd and a standard **driver-side sliding door** to access it.

SELECT STANDARD FEATURES

- Easy Out Roller Seats® (bench seats only)
- Four-wheel antilock brakes
- Four-speed electronic automatic transaxle
- Child-protection sliding door locks
- Comfort-Fit Seat Belt System™ on outboard front and intermediate seats
- Power windows, rear vents and door locks
- Steering wheel radio controls
- Fog lamps
- Remote keyless entry with panic button
- Quad headlamps
- Next Generation driver and front-passenger air bags.

Certified to the Federal Regulations that allow less forceful air bags. Always use seat belts. Remember a backseat is the safest place for children.

Available Integrated Child Seat helps keep your young passenger safe and secure.

For children at least one year old, weighing between 22 and 50 pounds and no more than 47 inches in height.



For three consecutive years, Town & Country has been named:

- An *Automobile Magazine* All-Star winner
- A Strategic Vision (1998) Total Quality Award winner for "Best Ownership Experience" in Minivans.*



Town & Country LXi in Forest Green Pearl Coat

*Based on Strategic Vision's 1996, 1997 and 1998 Vehicle Experience Studies™ 35,652 ('96), 31,521 ('97) and 32,191 ('98) Oct.-Nov. new vehicle buyers 200+ models after the first 90 days of ownership.

Up to 14 cup and juice box holders in Town & Country can accommodate many shapes. A lockable drawer beneath the front passenger seat (on SX and LX models) provides a handy storage area.



Elegant and comfortable Wanderer leather-trimmed seating and Quad-Command convenience is included on Town & Country LXi.



TOWN & COUNTRY LX AND SX



The 3.3-liter V6; which produces 176 horsepower, is standard on Town & Country LX and SX.

*3.3 liter engines outside of CA, MA and NY have flex fuel (ethanol and unleaded gasoline) capability.

TOWN & COUNTRY LX is the definitive minivan for drivers who prefer to choose their own blend of refinements. Furnished with the expected standard features, the long-wheelbase LX offers a diversity of options for individual personalization. The short-wheelbase **Town & Country SX** is designed for owners who choose space efficiency and enhanced agility.

All-wheel drive, (right) provides directional stability and confident steering in inclement driving conditions, and is available on all long-wheelbase Town & Country models. A unique viscous coupling applies power to the front or rear wheels, depending on where it is needed most.



Town & Country SX (top) in Candy Apple Red Metallic
Town & Country LX in Deep Slate Pearl Coat

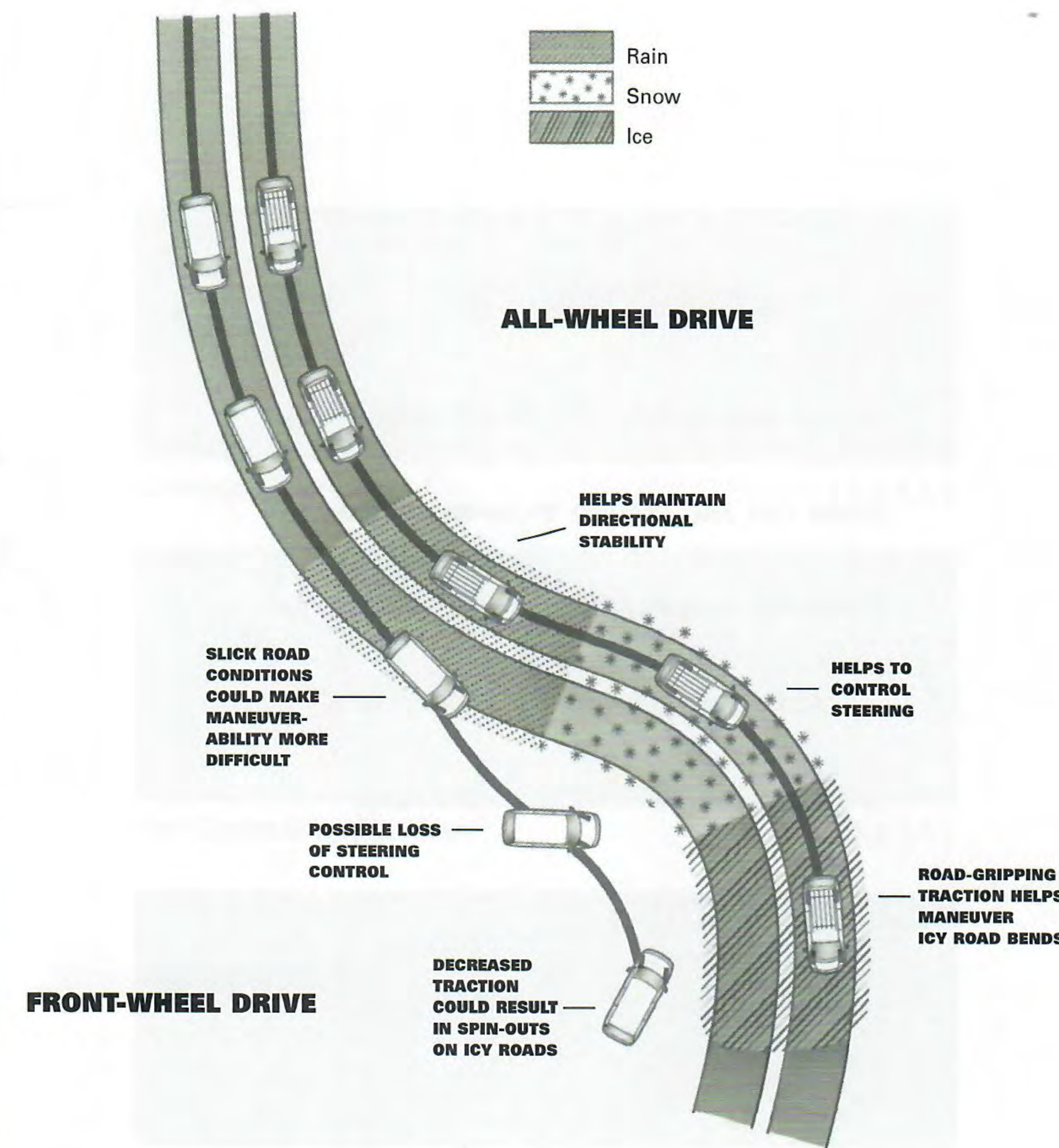

CUSTOMER ONE CARE™

At Chrysler Corporation, our commitment to complete customer satisfaction is evident in every car and minivan we sell. Long after a vehicle is driven away from the showroom, we will be there to ensure that our customers remain pleased with every new-vehicle purchase. To prove this commitment, all Chrysler Corporation vehicles are covered by the 3/36 Customer One Care Plan*, which includes a 3-year/36,000-mile (whichever comes first) Bumper-to-Bumper Limited Warranty† and Roadside Assistance‡ for 3 years or 36,000 miles. Roadside Assistance provides 24-hour, 7-day-a-week Emergency Road Service, contacted by a nationwide toll-free number. A 5-year or 100,000-mile Outer-Panel Rust-Through Limited Warranty covers the cost of all parts and labor needed to repair exterior sheet metal panels perforated by corrosion. The 3/36 Customer One Care Plan stays with the vehicle, transferring automatically to subsequent owners at no cost during the warranty period.

*See your dealer for additional details and a copy of this limited warranty.
†Covers the complete vehicle against defects in materials and workmanship. Excludes wiper blades, clutch and brake linings, brake rotors and drums, normal maintenance items and tires (covered by their own manufacturers' warranty).
‡Roadside Assistance services are provided by Cross Country Motor Club, Inc. (In California, Cross Country Motor Club of California, Inc.)

LEASING

Leasing is a popular way to finance a new vehicle and Chrysler Financial's **Gold Key Lease** has the flexibility to fit your vehicle choice and your lifestyle. Lease payments are typically lower and for a shorter term than conventional financing. At lease end, you can: **1)** turn the vehicle in and lease a new one; **2)** buy the vehicle and keep it; **3)** buy the vehicle and sell it for a possible profit. If the idea of driving the vehicle you want and paying less for it sounds great, ask about Gold Key Lease. **Gold Key Plus** is a great leasing option for customers who want low lease payments and pride of vehicle ownership—Gold Key Plus offers both. Decide how long the vehicle will be driven and the trade-in value is guaranteed (less excess mileage and wear and tear). Ask your dealer for complete details. **Commercial Finance Options (CFO)** offers several finance and lease options to small and midsize businesses, municipalities and small fleet operators. A full range of automotive financing is available through Chrysler Financial, providing flexible payment plans and finance products for qualified buyers. Many of these plans can be customized to fit your particular budget and make your new vehicle even more affordable. The **College Graduate Program** is especially attractive to those just beginning their careers. Ask your salesperson for details about any of the above plans. Chrysler Financial's programs are subject to availability and state and local laws.

All product illustrations and specifications are based upon current information at the time of publication approval. Although descriptions are believed correct, complete accuracy cannot be guaranteed. Chrysler Corporation reserves the right to make changes from time to time, without notice or obligation, in prices, specifications, colors and materials, and to change or discontinue models. See your dealer for the latest information.

Chrysler, 300M, LHS, Concorde, Cirrus, Sebring, Town & Country, Mopar, Hemi, Easy Out Roller Seats, Sentry Key and Customer One Care are trademarks of Chrysler Corporation. HomeLink is a registered trademark of the Prince Corporation. Infinity Spatial Imaging is a trademark of Infinity Systems, Inc. Preferred Suede is a registered trademark of Milliken and Company.

Always use seat belts. Remember a backseat is the safest place for children.

**FOR MORE INFORMATION ON PRODUCTS OR LEASING:
1-800-CHRYSLER
www.chryslercars.com**

Form No. 74-383-9931

9/98(600M)

Litho in USA

EXTERIOR COLORS

AN APPEALING ARRAY OF CON-

TEMPORARY COLORS has been selected

to set off Chrysler's sophisticated family members.

The full range of exterior paint colors is displayed

here to guide your selection. Beneath each of the

color samples are the numerals, keyed to the

Legend at right, that indicate which vehicles are

available in that color. **Interior fabrics and**

leathers, in a selection of compatible colors,

can be seen at your Chrysler dealership. Your

dealer can also provide an extensive lineup of

Chrysler Accessories from Mopar that

will add even more comfort and convenience

to the models described in this brochure.

LEGEND:

- | | |
|-------------------|-------------------------|
| 1 - Chrysler 300M | 5 - Sebring Convertible |
| 2 - Chrysler LHS | 6 - Sebring Coupe |
| 3 - Concorde | 7 - Town & Country |
| 4 - Cirrus LXi | |



Deep Cranberry Pearl Coat 1, 2, 3, 4, 5, 7



Candy Apple Red Metallic 1, 3, 7



Indy Red 6



Flame Red 5



Inferno Red Tinted Clear Coat 4, 5



Paprika Pearl Coat 6



Cinnamon Glaze Metallic 1, 2



Caffe Latte 6



Champagne Pearl Coat 1, 2, 3, 4, 5, 7



Light Cypress Green Pearl Coat 1, 2, 3, 4, 5, 7



Forest Green Pearl Coat 1, 2, 3, 4, 5, 7



Polo Green Pearl Coat 6



Deep Amethyst Pearl Coat 1, 2, 3, 4, 5, 7

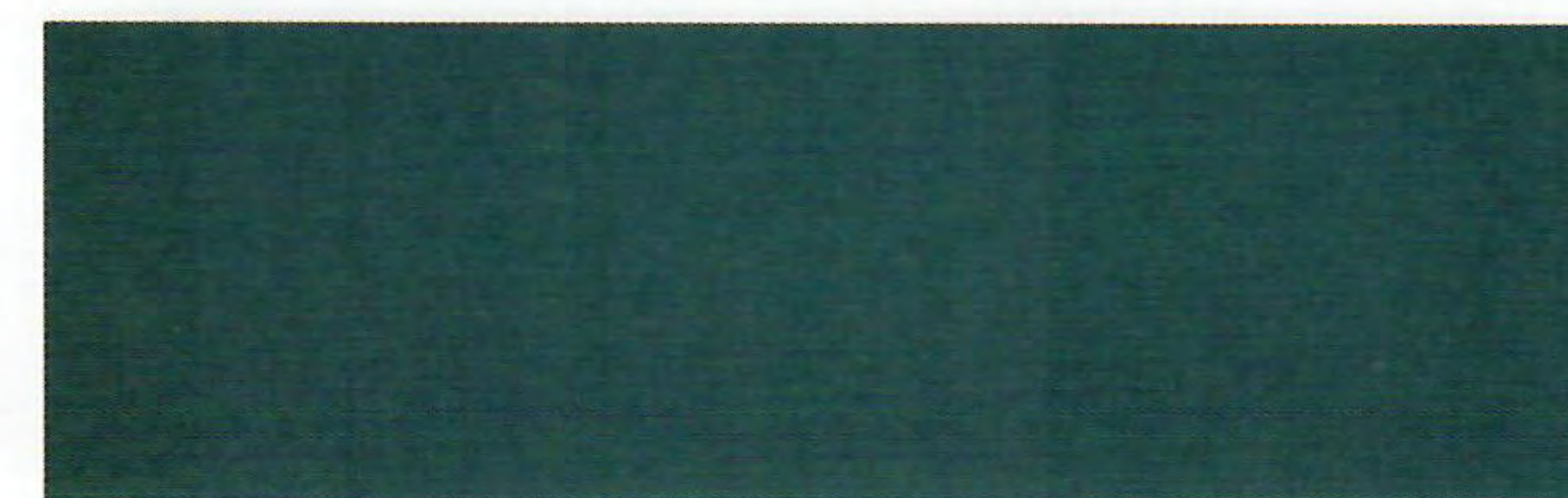

Shark Blue Pearl Coat 6



Deep Slate Pearl Coat 1, 2, 3, 4, 5, 7

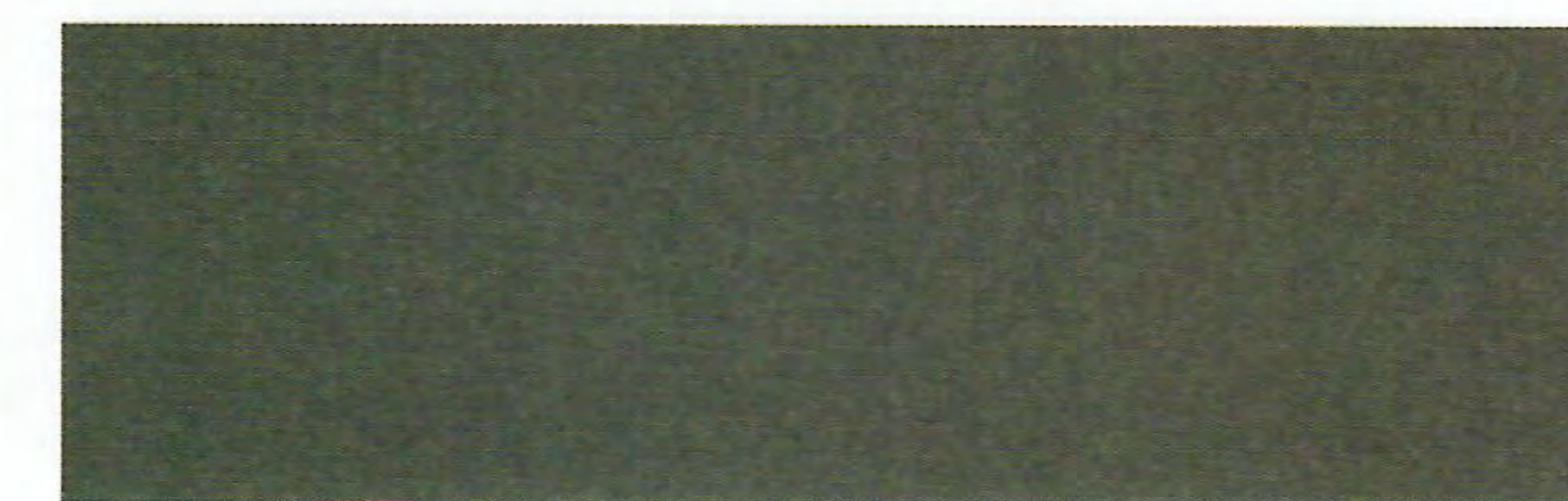

Taupe Frost Pearl Coat 7



Bright Platinum Metallic 1, 2, 3, 4, 5

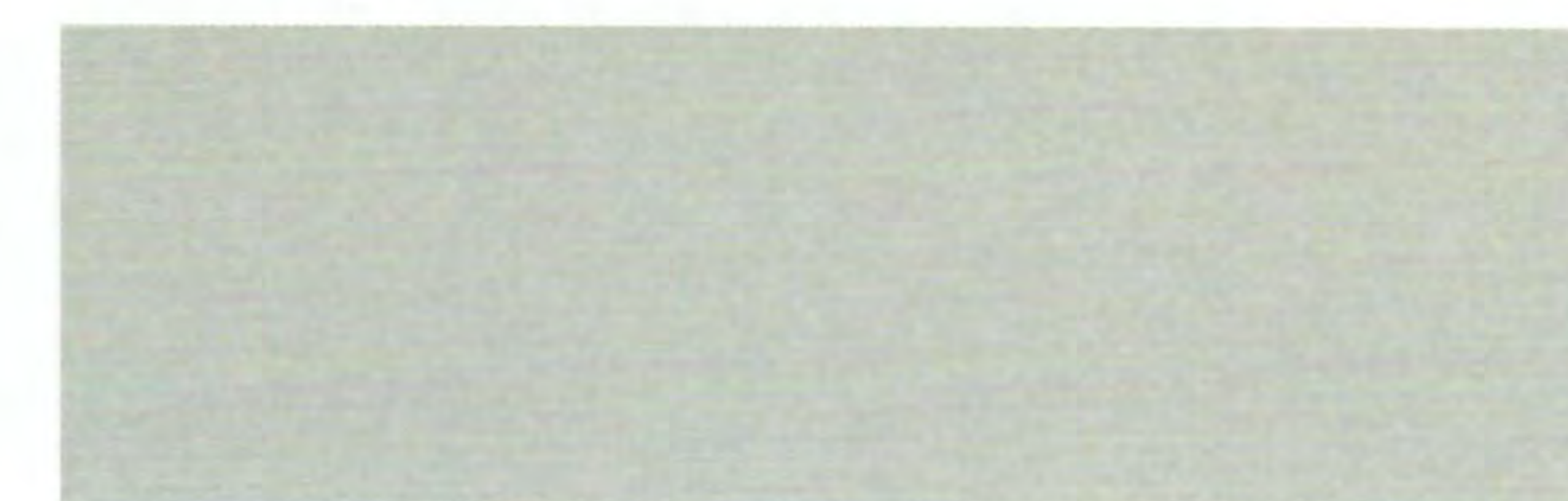

Silver Mist 6



Golden White Pearl Tri-Coat 7



Bright White 5, 6



Stone White 1, 2, 3, 4



Black 6

If you would like to discuss vehicle details or pricing with a knowledgeable advisor before visiting your dealer, call 1-800-CHRYSLER or visit our Web site at www.chryslercars.com

1999 Chrysler

Built on the belief that while
all cars appeal to our practical side,
the great ones appeal
to a more passionate side.

CHRYSLER



ENGINEERED TO BE GREAT CARS